

Centre Number						Candidate Number				
Surname										
Other Names										
Candidate Signature										

For Examiner's Use	
Examiner's Initials	
Question	Mark
1	
2	
3	
4	
5	
6	
7	
TOTAL	



General Certificate of Secondary Education
Higher Tier
June 2012

Additional Science

Unit Chemistry C2

CH2HP

Chemistry

Unit Chemistry C2

H

Thursday 24 May 2012 9.00 am to 10.00 am

For this paper you must have:

- a ruler
 - the Chemistry Data Sheet (enclosed).
- You may use a calculator.

Time allowed

- 1 hour

Instructions

- Use black ink or black ball-point pen.
- Fill in the boxes at the top of this page.
- Answer **all** questions.
- You must answer the questions in the spaces provided. Do not write outside the box around each page or on blank pages.
- Do all rough work in this book. Cross through any work you do not want to be marked.

Information

- The marks for questions are shown in brackets.
- The maximum mark for this paper is 60.
- You are expected to use a calculator where appropriate.
- You are reminded of the need for good English and clear presentation in your answers.
- Question 2(a) should be answered in continuous prose.
In this question you will be marked on your ability to:
 - use good English
 - organise information clearly
 - use specialist vocabulary where appropriate.

Advice

- In all calculations, show clearly how you work out your answer.



J U N 1 2 C H 2 H P 0 1

Answer **all** questions in the spaces provided.

- 1 Icing on cakes is tested to check that safe colours were used when they were made.



Paper chromatography is one method of testing which colours are in cake icing.

- 1 (a) The diagram shows an experiment a student did.

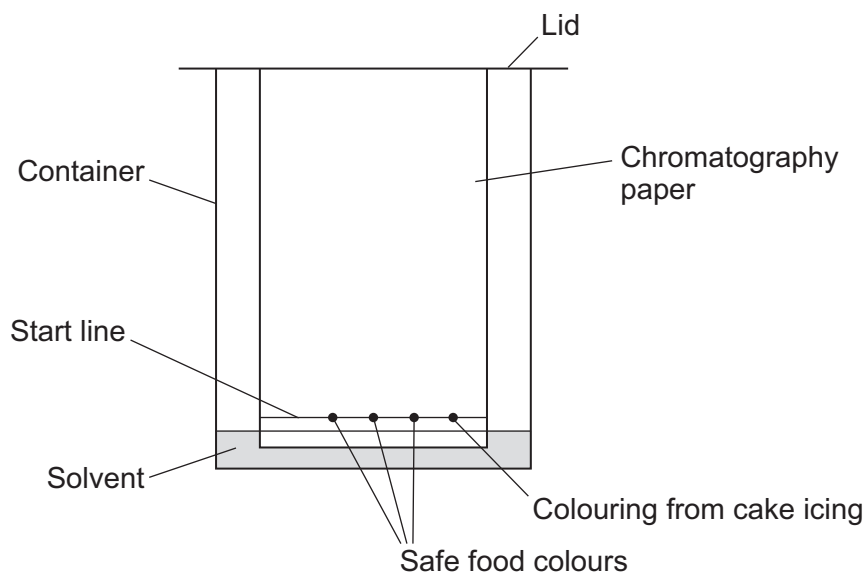

- 1 (a) (i) Suggest why there is a lid on the container.

.....

 (1 mark)

- 1 (a) (ii) The start line should be drawn in pencil **not** in ink.
 Suggest why.

.....

 (1 mark)



1 (b) The diagram shows the results of the paper chromatography experiment.

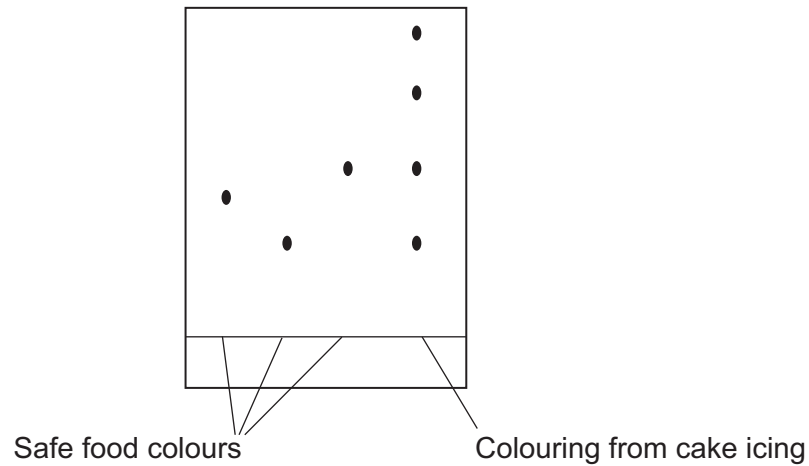

1 (b) (i) How many different food colours were used in the colouring from the cake icing?

.....
(1 mark)

1 (b) (ii) Is the cake icing safe to eat?

Give a reason for your answer.

.....
.....
(1 mark)

Question 1 continues on the next page

Turn over ►



1 (c) Gas chromatography linked to mass spectroscopy is an example of an instrumental method. This method was used on a mixture of solvents.

1 (c) (i) Give **two** advantages of gas chromatography compared with paper chromatography.

.....
.....
.....
.....

(2 marks)

1 (c) (ii) What does gas chromatography do to the mixture of solvents?

.....
.....

(1 mark)

1 (c) (iii) What information does mass spectroscopy give?

.....
.....

(1 mark)

8



2 (a) *In this question you will be assessed on using good English, organising information clearly and using specialist terms where appropriate.*

The salt called potassium chloride is made when potassium hydroxide solution reacts with hydrochloric acid.

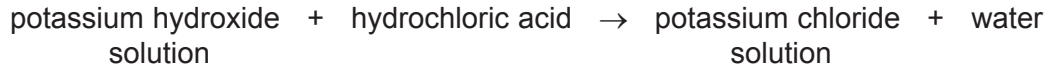

Describe a method for making **crystals** of potassium chloride from potassium hydroxide solution and hydrochloric acid.

In this method you should:

- describe how you will add the correct amount of the hydrochloric acid to neutralise the potassium hydroxide solution
- describe how you will get crystals of potassium chloride.

.....

.....

.....

.....

.....

.....

.....

.....

.....

.....

.....

.....

.....

.....

.....

.....

.....

.....

.....

.....

.....

.....

.....

.....

.....

.....

.....

(6 marks)

Question 2 continues on the next page

Turn over ►



- 2 (b)** Ammonium nitrate is another salt.
Ammonium nitrate is made when ammonia solution is neutralised with an acid.

Name the acid to complete the word equation.

ammonia + acid → ammonium nitrate
(1 mark)

- 2 (c)** Read the information.

Ammonium nitrate – good or bad?

Some farmers put a lot of ammonium nitrate on their farmland.

Many people are worried about this use of ammonium nitrate.

Rain water can wash the ammonium nitrate off the farmland and into rivers and lakes. The ammonium nitrate may get into drinking water supplies and could be harmful to health.

- 2 (c) (i)** Why do some farmers put ammonium nitrate on their farmland?

.....
.....

(1 mark)



2 (c) (ii) Which **one** of the questions in the table cannot be answered by science alone?

Tick (✓) **one** question.

Question	Tick (✓)
How much ammonium nitrate is in drinking water?	
Should farmers stop using ammonium nitrate on their farmland?	
Is ammonium nitrate soluble in rain water?	

Give **two** reasons why this question **cannot** be answered by science alone.

.....

.....

.....

.....

(3 marks)

11

Turn over for the next question

Turn over ►



- 3 The symbol equation for the decomposition of hydrogen peroxide is:

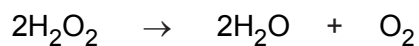

- 3 (a) This reaction is *exothermic*.

What is an *exothermic* reaction?

.....

.....

(1 mark)

- 3 (b) A student measured the volume of oxygen produced by 50 cm³ of hydrogen peroxide.

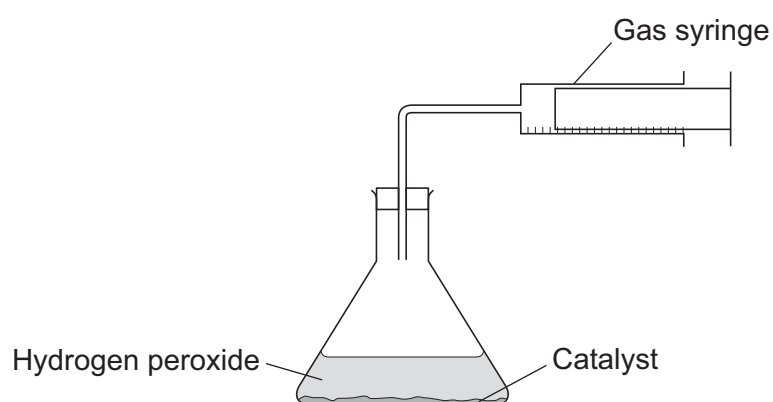

The graph shows the results.

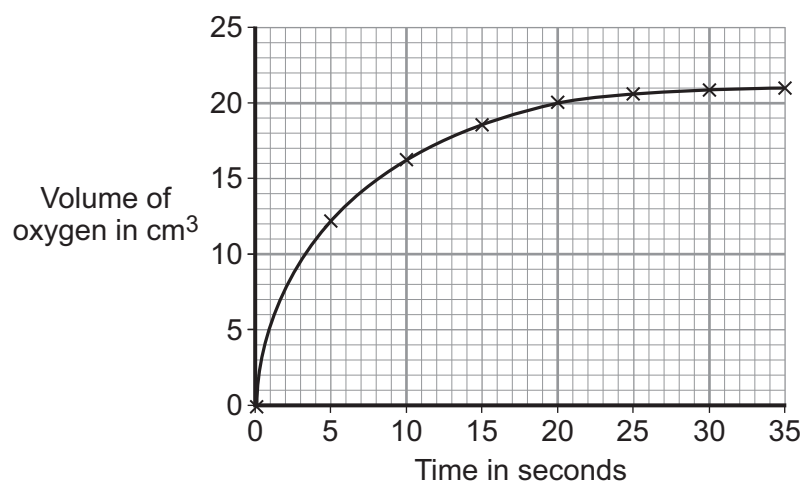

3 (b) (i) Use the graph to describe the changes in the rate of the reaction from 0 to 35 seconds.

.....
.....
.....
.....
.....
.....

(3 marks)

3 (b) (ii) What was the total volume of oxygen gas collected? cm³
(1 mark)

3 (b) (iii) The student had calculated that the hydrogen peroxide used should produce 25 cm³ of oxygen.

Calculate the percentage yield of oxygen.

.....
.....
.....

Answer = %
(2 marks)

3 (c) An increase in the temperature of the hydrogen peroxide increases the rate of the reaction.

Use your knowledge of particles to explain why.

.....
.....
.....
.....
.....
.....

(3 marks)

10

Turn over ►



4 This question is about gold (Au).

4 (a) An atom of gold is represented as:



How many neutrons are in this atom of gold?
(1 mark)

4 (b) Gold ions are used as a catalyst.

How does a gold atom (Au) become a gold ion (Au³⁺)?

.....
.....
.....
.....
(2 marks)



4 (c) A gold catalyst can be used when carbon monoxide reacts with oxygen to make carbon dioxide.

4 (c) (i) Complete and balance the equation for this reaction.

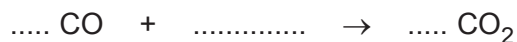

(2 marks)

4 (c) (ii) Carbon dioxide has a very low boiling point.

Explain why.

.....

.....

.....

.....

.....

.....

(3 marks)

4 (d) Gold is used as a catalyst in industrial processes. Gold is rare and increasingly expensive.

Suggest **three** reasons why gold is still used in industrial processes.

.....

.....

.....

.....

.....

.....

(3 marks)

11

Turn over for the next question

Turn over ►



5 Aluminium is extracted from aluminium oxide.

5 (a) The formula of aluminium oxide is Al_2O_3

The relative formula mass (M_r) of aluminium oxide is 102.

Calculate the percentage of aluminium in aluminium oxide.

Relative atomic masses (A_r): O = 16; Al = 27.

.....

.....

.....

.....

Percentage of aluminium = %
(2 marks)

5 (b) Aluminium is extracted from aluminium oxide using electrolysis.

The diagram shows a cell used for the extraction of aluminium.

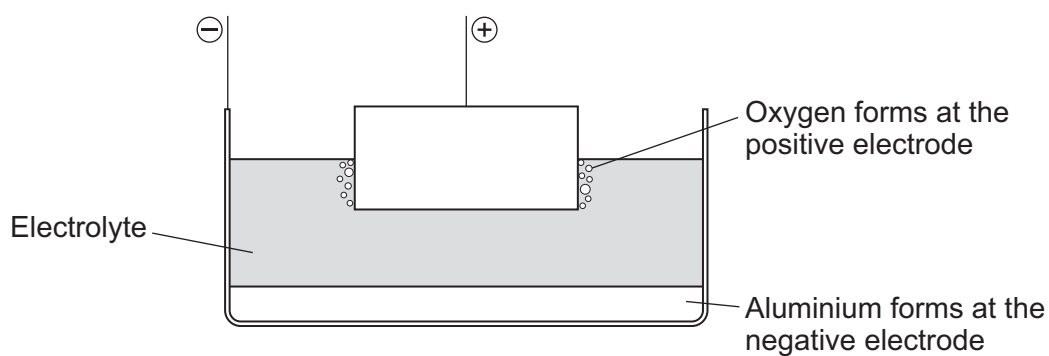

5 (b) (i) The electrolyte contains cryolite.

Explain why.

.....
.....
.....
.....

(2 marks)

5 (b) (ii) Oxygen is formed at the positive electrode. Complete and balance the equation for this reaction.

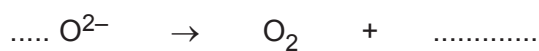

(2 marks)

5 (b) (iii) The positive electrode in the cell is used up during the process.

Explain why.

.....
.....
.....
.....
.....
.....

(2 marks)

8

Turn over for the next question

Turn over ►



6 This question is about calcium hydroxide.

Ancient artworks and monuments can be protected from acid rain if the surface is sprayed with calcium hydroxide nanoparticles.



6 (a) Calcium hydroxide has the formula $\text{Ca}(\text{OH})_2$

Why are there two hydroxide ions for each calcium ion in the formula?

.....
.....
.....

(1 mark)

6 (b) The calcium hydroxide is used in the form of *nanoparticles*.

What are *nanoparticles*?

.....
.....

(1 mark)



6 (c) A student added water to calcium oxide to make calcium hydroxide.

The equation for the reaction is shown below.



Calculate the maximum mass of calcium hydroxide which could be made from 2.00 g of calcium oxide.

Relative atomic masses (A_r): H = 1; O = 16; Ca = 40.

.....

.....

.....

.....

.....

.....

Maximum mass of calcium hydroxide = g
(3 marks)

5

Turn over for the next question

Turn over ►



- 7 Graphite and diamond are different forms of the element carbon.
Graphite and diamond have different properties.

The structures of graphite and diamond are shown below.

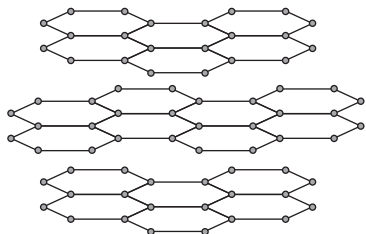

Graphite

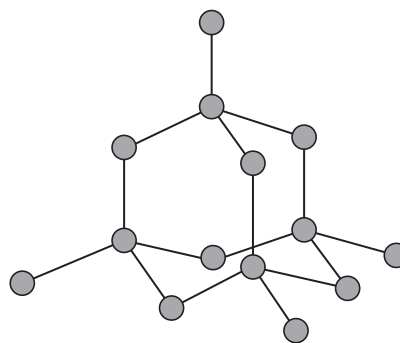

Diamond

- 7 (a) Graphite is softer than diamond.

Explain why.

.....

.....

.....

.....

.....

.....

.....

.....

(4 marks)



7 (b) Graphite conducts electricity, but diamond does not.

Explain why.

.....

.....

.....

.....

.....

.....

(3 marks)

7

END OF QUESTIONS



There are no questions printed on this page

**DO NOT WRITE ON THIS PAGE
ANSWER IN THE SPACES PROVIDED**



There are no questions printed on this page

**DO NOT WRITE ON THIS PAGE
ANSWER IN THE SPACES PROVIDED**



There are no questions printed on this page

**DO NOT WRITE ON THIS PAGE
ANSWER IN THE SPACES PROVIDED**

ACKNOWLEDGEMENT OF COPYRIGHT-HOLDERS AND PUBLISHERS

Question 1 Photograph © Thinkstock
Question 6 Photograph © Thinkstock

Copyright © 2012 AQA and its licensors. All rights reserved.

